

細部放大圖 A
比例 1 : 5

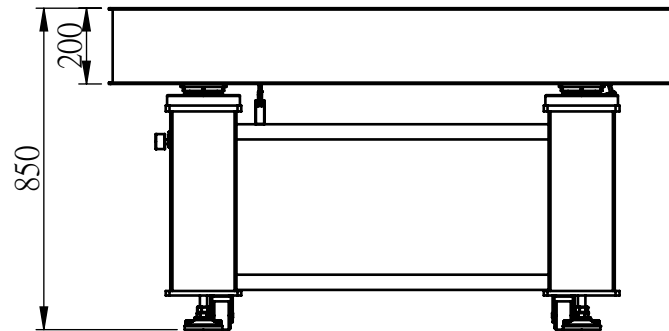

M-OTA3-150150-20